

A VARIATIONAL PRINCIPLE FOR BOUND STATES
IN QUANTUM FIELD THEORY

J. Greensite

Department of Physics and Astronomy
San Francisco State University
1600 Holloway Avenue
San Francisco, California 94132

M. B. Halpern*†

Department of Physics
University of California
Berkeley, California 94720

Abstract

We develop a Rayleigh-Ritz variational method for estimating relativistic, multi-particle bound state energies in any (weak-coupling) quantum field theory. A comparison is made with bound state energies derived from the Bethe-Salpeter equation in the Wick-Cutkosky model. Possible applications to QCD are discussed.

1. Introduction

Nature exhibits a large variety of more or less relativistic bound state systems, from uranium and positronium through charmonium, glueballs, and presumably the entire hadron spectrum. The Bethe-Salpeter equation has long been the standard method for dealing with relativistic bound states, and much progress has been made, especially for fundamentally weak-coupling, two-body problems such as positronium [1,2]. However, the Bethe-Salpeter approach becomes progressively more complicated in the case of particle bound states, which include, e.g., the QCD baryons, quark mesons, and any excited meson state which can be regarded as a bound state of quarks plus one or more "valence" or constituent gluons [3]. Another example from QCD is the QCD string itself. According to a picture of confinement advocated by Greensite [4] and Thorn [5], the QCD string consists of a chain of "constituent" gluons, with each gluon held in place by its attraction to its nearest neighbors in the chain. This picture suggests the possibility of a perturbative calculation of the energy/unit-length of the gluon chain. But to carry out this calculation, or any other calculation of energies in a relativistic many-particle bound state, the Bethe-Salpeter approach is not very practical, and other methods must be devised. Of course even in non-relativistic physics, the problem of solving a many-body Schrödinger equation (arising, e.g., in atomic physics) can be completely intractable. Traditionally, variational methods have always been simpler than Schrödinger equation methods, and are often quite accurate.

*This work supported by the National Science Foundation under Research Grant No. PHY-81-18547.

†This work was supported by the Director, Office of Energy Research, Office of High Energy and Nuclear Physics Division of High Energy Physics of the U.S. Department of Energy under Contract DE-AC03-76SF00098.

This article is concerned with generalizing the Rayleigh-Ritz method to relativistic quantum field theory. The method we propose is similar in spirit to a variational method that has been used in lattice Monte Carlo calculations of the glueball mass [6]. However, there are important differences between our method and the lattice method. In particular, we introduce a procedure called "time-splitting", which is essential for any perturbative calculation of bound-state interaction energies.

In the next section, section 2, we discuss the problems involved in generalizing the Rayleigh-Ritz method to relativistic systems, and outline our approach. In section 3 the generalized variational method is applied, for purposes of comparison, to the Wick-Cutkosky model. This model is a scalar field theory with cubic couplings for which analytical solutions of the Bethe-Salpeter equation are available [2]. The variational Feynman rules are derived in section 3, and it is shown in detail why time-splitting is necessary to obtain the correct non-relativistic limit. Results for the relativistic case are presented in section 4. We conclude in section 5 with a discussion of possible applications to QCD.

2. The Variational Method and Time-Splitting

The Rayleigh-Ritz method is familiar from any text on non-relativistic quantum mechanics. The reason that its extension to the relativistic theory is not completely straightforward is due to the following differences between quantum mechanics and field theory.

- 1) In quantum mechanics, the ground state is simply the lowest lying bound state. In field theory, the ground state is the vacuum; bound states are all excitations above the vacuum. Estimating bound state energies in field theory therefore requires the vacuum state as a starting point.
- 2) In quantum mechanics, a state is completely specified by the wavefunction of the constituent particles. In field theory, the constituent particles (the quarks, say) are themselves sources of relativistic fields. Then because field propagation is not instantaneous, the field surrounding the constituents at time t is not determined by the constituent particle wavepacket at time t . So in addition to the constituent particles, the state of the quanta of the induced field (the gluons, say) must also be specified.

The first problem is solved by using a functional integral representation of the vacuum (as suggested by Wilson [7] in connection with variational Monte Carlo calculations [6]). Let $L[\phi]$ be the Euclidean Lagrangian density of the field $\phi(x,t)$. Then an exact representation of the vacuum wavefunctional at time $t = 0$ is

$$\Psi_0(\phi(x,0)) = \int \mathcal{D}\phi(x,t < 0) e^{-\int dt \int d^D x L(\phi(x,t))} \quad (2.1)$$

It is easy to see that if $\Lambda(\phi(x,0))$ is any operator defined on the $t=0$ hypersurface, then

$$\begin{aligned} \langle A \rangle &= \frac{\langle \psi_0 | \Lambda | \psi_0 \rangle}{\langle \psi_0 | \psi_0 \rangle} \\ &= \frac{1}{2} \int \mathcal{D}\phi(x,0) \psi_0^*[\phi(x,0)] \Lambda[\phi(x,0)] \psi_0[\phi(x,0)] \\ &= \frac{1}{2} \int \mathcal{D}\phi \Lambda[\phi(x,0)] e^{-\int_{-\infty}^{\infty} dt d^Dx L(\phi(x,t))} \end{aligned} \quad (2.2)$$

that is, $\langle A \rangle$ is determined by the usual Euclidean functional integral. Equation (2.1) actually follows from the fact that

$$\begin{aligned} Z[\phi(xt_2), \phi(xt_1)] &= \int \mathcal{D}\phi(x, t_1 < t < t_2) e^{-\int_{t_1}^{t_2} dt \int d^Dx L(\phi(x,t))} \\ &= \sum_n e^{-(t_2-t_1)E_n} \psi_n^*[\phi(xt_2)] \psi_n[\phi(xt_1)] \end{aligned} \quad (2.3)$$

so that taking $t_2 = 0$ and $t_1 \rightarrow -\infty$ singles out the ground state. Now suppose we are interested in the lowest mass bound state $|B\rangle$ in a channel with quantum numbers different from the vacuum. Let $Q(\phi(x,0))$ be any operator such that

$$\begin{aligned} \psi_{\text{trial}} &= Q\psi_0, \\ \langle B | \psi_{\text{trial}} \rangle &= \langle B | Q | \psi_0 \rangle \neq 0. \end{aligned} \quad (2.4)$$

Then a rigorous upper bound on the lowest bound state mass is just

$$\begin{aligned} m_B \leq E_{\text{trial}} &= \frac{\langle \psi_{\text{trial}} | H | \psi_{\text{trial}} \rangle}{\langle \psi_{\text{trial}} | \psi_{\text{trial}} \rangle} - \langle H \rangle \\ &= \frac{\langle \psi_0 | Q^\dagger H Q | \psi_0 \rangle - \langle H \rangle \langle Q^\dagger Q \rangle}{\langle Q^\dagger Q \rangle} = \langle Q^\dagger H Q \rangle_{\text{conn}}, \end{aligned} \quad (2)$$

where $\langle \cdot \rangle_{\text{conn}}$ means, diagrammatically, to include only diagrams in which H is connected to Q^\dagger, Q . Then by parametrizing the operator Q , and varying the parameters to minimize E_{trial} one hopes to get a good estimate of m_B . Note that if B has the same quantum numbers as the vacuum, we can simply redefine

$$\tilde{Q} = Q - \langle Q \rangle$$

and minimize

$$E_{\text{trial}} = \frac{\langle \tilde{Q}^\dagger H \tilde{Q} \rangle_{\text{conn}}}{\langle \tilde{Q}^\dagger \tilde{Q} \rangle}$$

The second problem mentioned above shows up when Q is chosen to create the wavepacket of constituent particles in the bound state. To be specific, consider a theory of two distinguishable (but equal mass) scalar fields ϕ_1 and ϕ_2 , which interact via exchange of a massless scalar field A . This is the Wick-Cutler model [2], with Euclidean action [1]

$$\begin{aligned} S_E &= \int d^4x \{ \phi_1^* (-\partial^2 + m^2) \phi_1 + \phi_2^* (-\partial^2 + m^2) \phi_2 \\ &\quad + \frac{1}{2} A (-\partial^2) A + g (\phi_1^* \phi_1 + \phi_2^* \phi_2) A \}. \end{aligned}$$

The force between massive scalars in this model is attractive so it is possible for ϕ_1 and ϕ_2 to form a 2-particle bound state

Then a natural choice for Q is

$$Q = \int \frac{d^3k_1}{(2\pi)^3} \frac{d^3k_2}{(2\pi)^3} \frac{d^3k_1' d^3k_2'}{2\omega_{k_1} 2\omega_{k_2}} f(\vec{k}_1, \vec{k}_2) \phi_1^*(\vec{k}_1, t=0) \phi_2^*(\vec{k}_2, t=0),$$

$$\phi(\vec{k}, t=0) = \int d^3x e^{i\vec{k} \cdot \vec{x}} \phi(x, t=0),$$

$$\omega_k = \sqrt{k^2 + m^2}, \quad (2.9)$$

i.e., Q is a 2-particle creation operator, and $f(\vec{k}_1, \vec{k}_2)$ is the momentum-space trial wavefunction for the bound-state wavepacket.

Now in the non-relativistic limit of the Wick-Cutkosky model, it is easy to verify that the interaction energy should be a Coulomb-type potential of the form

$$E_{\text{int}} \approx e^2 \int \frac{d^3k_1}{(2\pi)^3} \frac{d^3k_1'}{(2\pi)^3} \frac{d^3k_2}{(2\pi)^3} f(\vec{k}_1, \vec{k}_1' + \vec{k}_2 - \vec{k}_1) f(\vec{k}_1', \vec{k}_2) \frac{1}{(\vec{k}_1 - \vec{k}_1')^2}. \quad (2.10)$$

But in fact, plugging (2.9) and the Wick-Cutkosky Hamiltonian into (2.5) (details are given in the next section), an explicit calculation gives the wrong result

$$E_{\text{int}} \approx \frac{e^2}{m} \int \frac{d^3k_1 d^3k_1' d^3k_2}{(2\pi)^3 (2\pi)^3 (2\pi)^3} f(\vec{k}_1, \vec{k}_1' + \vec{k}_2 - \vec{k}_1) f(\vec{k}_1, \vec{k}_2) \frac{1}{|\vec{k}_1 - \vec{k}_1'|}. \quad (2.11)$$

This potential does not even lead to a bound state at weak coupling.

What has gone wrong is that the operator Q, although it creates a state with the correct quantum numbers and constituents ϕ_1, ϕ_2 , does not excite the appropriate corresponding modes

of the massless A field. Then the only A-field quanta that can be absorbed by ϕ_1, ϕ_2 , at time $t = 0$ must have been emitted in vacuum pair-production processes at time $t < 0$. These are purely relativistic processes and lead, not to a Coulomb potential, but to a potential of the form (2.11).

The problem is simply that the massive scalar particles, which are both created and destroyed at $t = 0$, don't have time to "dress" themselves with a cloud of massless A - particles. This suggests a possible resolution - to create the massive particles at some earlier (Euclidean) time $t = -T < 0$. So define

$$Q_{-T} = \int \frac{d^3k_1}{(2\pi)^3} \frac{d^3k_2}{(2\pi)^3} f(\vec{k}_1, \vec{k}_2) \sqrt{2\omega_{k_1} 2\omega_{k_2}} \phi_1^*(\vec{k}_1, -T) \phi_2^*(\vec{k}_2, -T),$$

$$\Psi_T(\phi_1, 2(x, 0), \Lambda(x, 0)) = \int \mathcal{D}\phi_1(x, t < 0) \mathcal{D}\phi_2(x, t < 0) \mathcal{G}^A(x, t < 0) \cdot Q_{-T}(\phi_1, 2(x, -T)) e^{-\int_{-\infty}^0 dt d^Dx L(\phi_1, \phi_2, A)}. \quad (2.12)$$

Then

$$E_B(T) = \frac{\langle Q_T^\dagger | \phi_{1,2}(x, T) \rangle \langle Q_{-T} | \phi_{1,2}(x, -T) \rangle}{\langle Q_T^\dagger Q_{-T} \rangle} \text{conn}$$

$$= \sum_n \frac{\langle 0 | Q_T^\dagger | B_n \rangle \langle B_n | Q_{-T} | 0 \rangle E_B}{\sum_n \langle 0 | Q_T^\dagger | B_n \rangle \langle B_n | Q_{-T} | 0 \rangle} e^{-2E_B T}$$

$$\geq m_B \quad (2.13)$$

where $|B_n\rangle$ label all states in the $|B\rangle$ channel, and E_B is the energy above vacuum. Note that in the $T \rightarrow \infty$ limit

$$m_B = \lim_{T \rightarrow \infty} E_B(T). \quad (2.14)$$

If we were able to calculate $\langle Q_{\tau}^{\dagger} Q_{-\tau} \rangle$ as $\tau \rightarrow \infty$, we could find the entire bound state spectrum simply by extracting the poles. Unfortunately it is not practical to take the $\tau \rightarrow \infty$ limit, since at large τ it becomes impossible to calculate $\langle Q_{\tau}^{\dagger} Q_{-\tau} \rangle$ perturbatively.

We will refer to the separation in (Euclidean) time between operators $Q_{-\tau}$ and Q_{τ}^{\dagger} as *time-splitting*. At $\tau = 0$ the interaction energy comes out wrong because there is not time for the massless quanta to propagate from one particle to another; the time-split is too small. At $\tau = \infty$ the correlation $\langle Q_{\tau}^{\dagger} Q_{-\tau} \rangle$ cannot be computed perturbatively; τ is too large. The trick is to choose τ large enough so that the constituents are "dressed" with their fields, but small enough so that all vacuum expectation values (VEVs) can be calculated perturbatively. That such a choice is possible, and leads both to the correct non-relativistic limit and to reasonably good agreement with the Bethe-Salpater equation, will be shown in the next section.

An alternate approach, which does not involve time-splitting, is to complicate Q by including operators to excite modes of the induced field, e.g.,

$$Q = \int d^3k_1 d^3k_2 f_2(k_1, k_2) \phi_1^{\dagger}(k_1) \phi_2^{\dagger}(k_2, 0) + \int d^3k_1 d^3k_2 d^3k_3 f_3(k_1, k_2, k_3) \phi_1^{\dagger}(k_1, 0) \phi_2^{\dagger}(k_2, 0) A(k_3, 0). \quad (2.15)$$

This is the road taken in lattice gauge theory, where one writes

$$Q = \sum_{C_{xy}} a(C_{xy}) \psi^{\dagger}(x) (U_{00} \dots U_{0C})_{xy} \psi(y), \quad (2.)$$

for a $q\bar{q}$ state, or

$$Q = \sum_C b(C) \tau_i (U_{UU} \dots U_{0C})_C \quad (2.)$$

for a pure glue state, with C_{xy} and C being open and closed paths on the lattice, respectively. But although this approach may work well for lattice theory at intermediate couplings, where C can be restricted to just a few of the shortest closed paths the infinite sum over closed paths required in the continuum theory is clearly impractical. Even for the Wick-Cutkosky model there is no obvious guide for choosing $f_3(k_1, k_2, k_3)$ in eq. (2.15) (and f_3 must be chosen carefully, because the proper correlation of $\phi_1 \phi_2$ with A is crucial). The advantage of time-splitting that it is not necessary to specify the A - state explicitly this is done automatically by the Euclidean functional integral

3. Feynman Rules, and the Non-Relativistic Limit

The quantity to be minimized is

$$E_B = \frac{\langle Q_{\tau}^{\dagger} Q_{-\tau} e^{-S} I \rangle_0}{\langle Q_{\tau}^{\dagger} Q_{-\tau} e^{-S} I \rangle_0} \quad (3)$$

where

$$\langle O \rangle_0 = \frac{\int \mathcal{D}\psi \mathcal{D}\bar{\psi} O e^{-S}}{\int \mathcal{D}\psi \mathcal{D}\bar{\psi} e^{-S}} \quad (3)$$

In the Wick-Cutkosky model,

$$Q_{-T} = \int \frac{d^3k_1}{(2\pi)^3} \frac{d^3k_2}{(2\pi)^3} f(k_1, k_2) / \sqrt{2\omega_{k_1} 2\omega_{k_2}} \phi_1^*(k_1, -T) \phi_2^*(k_2, -T),$$

$$Q_T^+ = \int \frac{d^3k_1}{(2\pi)^3} \frac{d^3k_2}{(2\pi)^3} f^*(k_1, k_2) / \sqrt{2\omega_{k_1} 2\omega_{k_2}} \phi_1(k_1, T) \phi_2(k_2, T), \quad (3.3)$$

and

$$H = \int d^3x \left(-\dot{\phi}_1^*(x) \dot{\phi}_1(x) + |\nabla \phi_1(x)|^2 + m^2 |\phi_1(x)|^2 \right. \\ \left. - \dot{\phi}_2^*(x) \dot{\phi}_2(x) + |\nabla \phi_2(x)|^2 + m^2 |\phi_2(x)|^2 \right. \\ \left. - \frac{1}{2} \dot{A}(x) \dot{A}(x) + \frac{1}{2} (\nabla A)^2 \right. \\ \left. + g (\phi_1^*(x) \phi_1(x) + \phi_2^*(x) \phi_2(x)) A(x) \right). \quad (3.4)$$

Eq. (3.4) makes use of the fact that, inside the Euclidean functional integral, the replacement

$$\begin{matrix} * \\ \pi \\ * \end{matrix} \rightarrow -\phi^* \phi \quad (3.5)$$

is valid, where π is the field momenta conjugate to ϕ .

The diagrammatic rules F3) for evaluating (3.1) are shown in Fig. 1. Solid lines are ϕ_1 , ϕ_2 propagators, dotted lines are A propagators. Cross (x) vertices are interaction vertices from the Hamiltonian; lines entering these vertices terminate at time $t = 0$. Dot (.) vertices come from expanding $\exp(-S_I)$. Propagators with (x) insertions represent the VEVs

$$\langle \phi^*(k_2, t_2) \phi(k_1, t_1) \rangle_0 = k_0(-t_1, t_2) e^{-\omega_{k_1} |t_2 - t_1|} (2\pi)^3 \delta^3(k_1 + k_2),$$

$$\langle A(k_2, t_2) A_0(k_1, t_1) \rangle_0 = k_0(-t_1, t_2) e^{-|k_1| \cdot |t_2 - t_1|} (2\pi)^3 \delta^3(k_1 + k_2). \quad (3.6)$$

With these rules, we find that the tree diagram contributions

to E_B , through order g^2 , are

$$E_B = \frac{N_0 + N_1 + N_2 + N_3}{D_0 + D_1} + O(g^3)$$

$$= \frac{1}{D_0} [N_0 (1 - \frac{D_1}{D_0}) + N_1 + N_2 + N_3] + O(g^3) \quad (3.7)$$

where N_0 , N_1 , N_2 , N_3 , D_0 , D_1 are represented by the diagrams shown in Fig. 2. F4) Explicitly

$$N_0 = \int \frac{d^3k_1}{(2\pi)^3} \frac{d^3k_2}{(2\pi)^3} f^*(k_1, k_2) f(k_1, k_2) |\omega_{k_1} \omega_{k_2}| e^{-2(\omega_{k_1} + \omega_{k_2})T},$$

$$D_0 = \int \frac{d^3k_1}{(2\pi)^3} \frac{d^3k_2}{(2\pi)^3} f^*(k_1, k_2) f(k_1, k_2) e^{-2(\omega_{k_1} + \omega_{k_2})T}, \quad (3.8)$$

are the zeroth order terms, and denoting

$$q \equiv |k_1^i - k_2^i|,$$

$$[dk] F = \frac{d^3k_1}{(2\pi)^3} \frac{d^3k_2}{(2\pi)^3} \frac{d^3k_1'}{(2\pi)^3} \frac{d^3k_2'}{(2\pi)^3} f(k_1, k_2) f(k_1', k_2')$$

$$\cdot [2\omega_{k_1} \omega_{k_2} \omega_{k_1'} \omega_{k_2'}] \delta^3(k_1 + k_2 - k_1' - k_2'), \quad (3.9a)$$

we have

$$D_1 = g^2 \int [dk] F \frac{1}{2q} \int dx_0 dy_0 e^{-q|x_0 - y_0|} e^{-[\omega_{k_1'} |T - x_0| + \omega_{k_1} |T + x_0|]} \cdot e^{-[\omega_{k_2'} |T - y_0| + \omega_{k_2} |T + y_0|]},$$

$$N_1 = 2g^2 \int [dk] F \frac{1}{2q} \int dx_0 dy_0 (\omega_{k_1} \theta(x_0) + \omega_{k_1'} \theta(y_0))$$

$$\cdot \exp[-q|x_0 - y_0| - \omega_{k_1'} |T - x_0| - \omega_{k_1} |T + x_0| - \omega_{k_2'} |T - y_0| - \omega_{k_2} |T + y_0|],$$

$$N_2 = -2g^2 \int (dk) F e^{-i\omega k_1 + i\omega k_2} \frac{1}{2q} \int dy_0 \exp(-q|y_0|)$$

$$e^{-i\omega k_2} |T-Y_0|^{-\omega k_2} |T+Y_0|,$$

$$N_3 = g^2 \int (dk) F k/dx_0 dy_0 \theta(-x_0 y_0)$$

$$\cdot \exp[-q|x_0 - y_0|^{-\omega k_1} |T-x_0|^{-\omega k_1} |T+x_0|^{-\omega k_2} |T-Y_0|^{-\omega k_2} |T+Y_0|] \quad (3.9b)$$

We first consider the non-relativistic limit. Suppose there is a range of couplings for which a non-relativistic bound-state emerges from the variational principle. In that range, one has $\omega \bar{k} = \sqrt{\bar{k}^2 + m^2} \gg \bar{k} > \frac{\bar{k}^2}{2m}$, where \bar{k} is the typical (i.e., rms) value of the relative momenta of the constituent particles. The typical value of momentum exchange q is also of order \bar{k} . By the Uncertainty Principle, $\bar{k} \approx 1/R$, where R is the diameter of the bound state.

The attractive Coulomb potential comes from the term N_2 . Apart from wavefunction and kinematical factors, the momentum-space potential energy from this term is

$$\begin{aligned} e^{+i\omega k_1 + i\omega k_2} V(q) &= \frac{1}{2q} \int_{-\infty}^{\infty} dy_0 e^{-q|y_0|} e^{-i\omega k_2} |T-Y_0|^{-\omega k_2} |Y_0 + T| \\ &= \frac{1}{2q} \left[\frac{e^{-i(\omega k_2 + \omega k_2)T}}{(q + \omega k_2 - \omega k_2)} - \{1 - e^{-i(\omega k_2 - \omega k_2)T}\} \right] \\ &\quad + \frac{1}{2q} \left[\frac{1}{(q + \omega k_2 - \omega k_2)} e^{-i(q+2\omega k_2)T} + (\omega k_2 + \omega k_2) \right], \quad (3.10) \end{aligned}$$

which becomes, in the non-relativistic limit,

$$\begin{aligned} V(q) &= \frac{1}{q} \left[e^{-\left[\frac{k_2^2}{2m} + \frac{k_2^2}{2m}\right]T} \right. \\ &\quad \left. + \frac{1}{q} \left[\frac{e^{-qT}}{q+2m} \right] e^{-4mT} \right] e^{-4mT} \end{aligned} \quad (3)$$

The first term in brackets comes from time integrations in the region $-T \leq Y_0 \leq T$, and corresponds to the diagram shown in Fig. In this process a quanta is emitted by ψ_1 and absorbed by ψ_2 ; this is the process which leads to the $1/r$ potential. The second term in brackets comes from the time integrations in the range $Y_0 < -T$ and $Y_0 > T$, and corresponds to the pair production process shown in Fig. 3b. If we take $T=0$, i.e., no time split, then pair production contributes, and

$$V(q) = \frac{1}{2mq} \quad (3)$$

which gives a $1/mr^2$, rather than $1/r$, attractive potential. mentioned in the introduction, this potential will not produce bound state at small g^2 . But if instead we choose T such that $\bar{k}T \gg 1$, $\frac{\bar{k}^2}{2m} T \ll 1$, or, in position space,

$$T \gg R, \quad T \ll 2mR^2, \quad (3)$$

then we have

$$V(q) = \frac{1}{q^2} e^{-4mT}. \quad (3)$$

Apart from the factor of $\exp(-4mT)$, which cancels against a similar factor in the denominator D_0 , this is the $1/r$ potential reduced. Evaluating all the other integrals in the non-relativistic

limit, with T satisfying (3.13) above, and choosing $f(k_1, k_2)$ to set up a zero total momentum eigenstate

$$f(k_1, k_2) = f(k_1)(2\pi)^3 \delta^3(k_1 + k_2), \quad (3.15)$$

we find

$$N_0 = 2mD_0 + \int \frac{d^3k}{(2\pi)^3} f^*(k) f(k) \frac{k^2}{m} e^{-4mT},$$

$$D_0 = \int \frac{d^3k}{(2\pi)^3} f^*(k) f(k) e^{-4mT},$$

$$N_1 = 2mD_1,$$

$$N_2 = - \left(\frac{q^2}{2m^2} \right) \int \frac{d^3k'}{(2\pi)^3} \int \frac{d^3k}{(2\pi)^3} f^*(k') f(k) \frac{1}{|k' - k|^2} e^{-4mT},$$

$$N_3 = -\frac{1}{2} N_2, \quad (3.16)$$

and therefore

$$E_B = 2m + \frac{\int \frac{d^3k}{(2\pi)^3} f^*(k) f(k) \frac{k^2}{m}}{\int \frac{d^3k}{(2\pi)^3} f^*(k) f(k)}$$

$$\frac{q^2}{4m^2} \frac{\int \frac{d^3k}{(2\pi)^3} \int \frac{d^3k'}{(2\pi)^3} f^*(k') f(k) \frac{1}{|k' - k|^2}}{\int \frac{d^3k}{(2\pi)^3} f^*(k) f(k)}$$

In position space, this gives

$$E_B = 2m + \frac{\int d^3x \psi^*(x) \left(-\frac{1}{2} \nabla^2 - \frac{e^2}{|x|} \right) \psi(x)}{\int d^3x \psi^*(x) \psi(x)}$$

where

$$\psi(x) = \int \frac{d^3k}{(2\pi)^3} f(k) e^{i\mathbf{k} \cdot \mathbf{x}} \quad (3.17)$$

and

$$e^2 = \frac{q^2}{16\pi m^2} \quad (3.18)$$

is the dimensionless coupling. Minimization of eq. (3.18) is simply the ordinary, non-relativistic Rayleigh-Ritz method for the Hamiltonian $H = -\frac{1}{2m} \nabla^2 - \frac{e^2}{r}$. The ground state energy of this Hamiltonian agrees precisely with the non-relativistic limit of the Wick-Cutkosky solution of the Bethe-Salpeter equation.

Note that all dependence on the time-split T has dropped out of the calculation, given that T is in the range (3.13). Since we know that for the non-relativistic bound state

$$\frac{1}{2mR^2} \approx \frac{e^2}{R} \quad (3.21)$$

the range for T is just

$$R \ll T \ll \frac{R}{e^2} \quad (3.22)$$

which is another way of seeing that the non-relativistic limit is an extreme weak-coupling limit $e^2 \ll 1$.

The role of the time-split in obtaining a $1/r$ potential should now be clear. The lower limit is simply to allow time for an exchange of A-quanta in units of the speed of light, but the necessity of the upper limit may not be obvious. This bound on T is required because the perturbative expansion for E_B will blow up, even if e^2 is very small, if T is too large. A condition that perturbation theory is valid is that $D_1 < D_0$, which means that the amplitude for one-particle exchange is smaller than the amplitude for free propagation. But in fact, it is easy to show that

$$\frac{D_1}{D_0} \sim e^2 \frac{T}{R} \quad (3.23)$$

Therefore, for $T \gg R/e^2$, perturbation theory certainly breaks down.

In fact, this breakdown has a simple, albeit heuristic, physical interpretation: In a real bound state of this kind, the particles ψ_1, ψ_2 are roughly a distance R apart, moving at velocities $v = \hbar/m = 1/(mR)$. Therefore, the time τ needed for the particles to go across the diameter of the bound state is approximately

$$\tau \approx mR^2 \approx \frac{R}{e^2} \tag{3.24}$$

If nothing would happen to prevent it, the particles would move outside the bound state region, so one or more quanta must be exchanged in this time interval to keep the wavefunction from spreading out. This means that over this time interval the amplitude for exchange exceeds the amplitude for free propagation, and perturbation theory must break down. To summarize, the inequality (3.22) means that, in order to compute bound states perturbatively, we must allow time for an exchange - so that the field energy has a chance to build up - but still keep the probability of an exchange reasonably small.

4. Relativistic Results

Next we consider the relativistic case. As e^2 increases, ψ_1 and ψ_2 start to move at a substantial fraction of the speed of light, and therefore τ approaches R . Then it is not possible to choose $T \gg R$ and still do perturbation theory. It is necessary instead that T and R have the same order of magnitude, and because $T \gg R$ is not possible, the potential will begin to deviate, in the relativistic case, from the $1/r$ form. F5)

Doing the time integrals in eq. (3.8-3.9), and without making

any nonrelativistic approximations, we have

$$N_0 = \int \frac{d^3k}{(2\pi)^3} f^*(k) f(k) (2\omega_k) e^{-4\omega_k T}$$

$$D_0 = \int \frac{d^3k}{(2\pi)^3} f^*(k) f(k) e^{-4\omega_k T}$$

$$D_1 = g^2 \int \frac{d^3k'}{(2\pi)^3} \frac{d^3k}{(2\pi)^3} f^*(k') f(k) \frac{1}{4\omega_k \omega_{k'}}$$

$$\cdot \frac{1}{2q} (W(\omega_k, \omega_{k'}) + W(\omega_k, \omega_k))$$

$$N_1 = 2g^2 \int \frac{d^3k'}{(2\pi)^3} \frac{d^3k}{(2\pi)^3} f^*(k') f(k) \frac{1}{4\omega_k \omega_{k'}}$$

$$\cdot \frac{1}{2q} (W(\omega_k, \omega_{k'}) + \omega_k W(\omega_k, \omega_k))$$

$$N_2 = -2g^2 \int \frac{d^3k'}{(2\pi)^3} \frac{d^3k}{(2\pi)^3} f^*(k') f(k) \frac{1}{4\omega_k \omega_{k'}}$$

$$\cdot \frac{1}{2q} [V(\omega_k, \omega_{k'}) + V(\omega_k, \omega_k)] e^{-(\omega_k + \omega_{k'})T}$$

$$N_3 = g^2 \int \frac{d^3k'}{(2\pi)^3} \frac{d^3k}{(2\pi)^3} f^*(k') f(k) \frac{1}{4\omega_k \omega_{k'}}$$

$$\cdot V(\omega_k, \omega_{k'}) V(\omega_k, \omega_k)$$

with

$$q = |\vec{k}' - \vec{k}|$$

$$V(\omega, \omega') = \frac{e^{-(\omega + \omega')T}}{q + \omega - \omega'} [1 - e^{-(q + \omega - \omega')T}]$$

$$+ \frac{e^{-(q + 2\omega)T}}{q + \omega + \omega'}$$

$$W(\omega, \omega') = 2(I_1 + I_2 + I_3) + V(\omega, \omega') V(\omega', \omega)$$

$$\begin{aligned}
 I_1 &= \frac{e^{-4\omega T}}{\omega + \omega' - q} \left[\frac{1}{\omega + \omega' + q} - \frac{1}{2(\omega + \omega')} \right] \\
 I_2 &= \frac{e^{-4\omega T}}{(q + \omega' - \omega)(q + \omega + \omega')} [1 - e^{-(q + \omega' - \omega)T}] \\
 I_3 &= \frac{e^{-2(\omega + \omega')T}}{q + \omega' - \omega} \left[\frac{1 - e^{-2(\omega - \omega')T}}{2(\omega - \omega')} \right. \\
 &\quad \left. - \frac{1 - e^{-(q + \omega - \omega')T}}{q + \omega - \omega'} \right]. \tag{4.1}
 \end{aligned}$$

In calculating E_B , an ansatz for $f(k)$ is needed. The non-relativistic solution is

$$\psi(x) = e^{-\alpha x}, \tag{4.2}$$

or

$$f(k) = \frac{8\pi\alpha}{(k^2 + \alpha^2)^2} \tag{4.3}$$

in momentum space, with

$$\begin{aligned}
 \alpha &= e^2/2 \\
 \Delta E_{NR} &= -\frac{e^4}{4}. \tag{4.4}
 \end{aligned}$$

Here, (in units $m = 1$) ΔE_{NR} is the binding energy of the lowest bound state in the Wick-Cutkosky model, in the non-relativistic limit.

In calculating the relativistic energy, denoted E_{RR}' , of a trial state, we have used the wavefunction $f(k)$ as an ansatz, with α a free parameter to be determined by minimization. Clearly $\alpha \approx 1/R$, where R is the radius of the bound state. The other free parameter is the time-split T , or, more conveniently, the dimensionless parameter $\tau = T\alpha \approx T/R$. The integrals in eq. (4.1) are all evaluated numerically.

We define

$$\Delta E_{RR}(\tau) = \min_{\alpha} E_B(\alpha, \tau) - 2m \tag{4.5}$$

as the Rayleigh-Ritz binding energy at fixed τ . This is an upper bound on the binding energy, up to $O(g^4)$ corrections, for any τ .

In Figs. 4-6 we plot $|\Delta E_{RR}|$, scaled by the $\psi_{1,2}$ mass m , as a function of τ . Also shown are $|\Delta E_{BS}|$, taken from the Wick-Cutkosky solution of the Bethe-Salpeter equation, and $|\Delta E_{NR}| = \frac{e^4}{4}$, the non-relativistic result, which of course are both constant in a plot against τ . At a very weak coupling $e^2 = .001$, shown in Fig. 4, ΔE_{RR} reaches its asymptotic value at a value $\tau \approx 8$, which is well within the range of validity of perturbation theory ($D_1/D_0 = .013$ at $\tau = 8$). In this range ($8 \lesssim \tau \lesssim 200$) there is almost no variation in ΔE_{RR} and the asymptotic value can be taken as the best upper bound. At $e^2 = .022$, shown in Fig. 5, relativistic effects start to become noticeable. At this coupling the asymptotic value is obtained at $\tau \approx 4$, where the ratio $D_1/D_0 = .12$, so this value should also be well within the range of validity of perturbation theory. Finally, at $e^2 = .5$, shown in Fig. 6, where relativistic effects are very large (ΔE_{NR} disagrees with ΔE_{BS} by about a factor of 2), $\Delta E_{RR}(\tau)$ again seems to approach an asymptotic value. Unfortunately, at this coupling the asymptotic value appears to be reached at a value $\tau = 2$, where $D_1/D_0 = .81$ and perturbation theory is very likely to be invalid. Therefore we are forced to choose τ to be inside the range of perturbation theory. This parameter is chosen (somewhat arbitrarily) to be the point where $D_1/D_0 = .5$.

So the principle for choosing τ at weak couplings is simply to treat τ as an extra variational parameter, and select the value which gives the lowest upper bound E_B . For weak couplings this

turns out to be the asymptotic value of the function $\Delta E_{RR}(\tau)$. (At very large values of τ , well outside the range of perturbation theory, the function $|\Delta E_{RR}(\tau)|$ decreases again, so the asymptotic value is in fact the maximum value). At moderate couplings, however, this principle cannot be applied, since as τ increases (and E_B computed to 2nd order in g decreases), the error due to neglecting higher order terms in perturbation theory also increases. We find in fact that the minimum (asymptotic) value of E_B at 2nd order lies outside the range of perturbation theory. It is therefore necessary to strike a balance between minimizing E_B , as computed to 2nd order, and minimizing the error in the calculation due to neglected higher-order terms. This can only be done quantitatively by actually calculating the magnitude of the 4th order terms (denoted by $|\delta_4(\tau)|$), and then minimizing $E_B(\tau) + |\delta_4(\tau)|$. This procedure would give a more controlled approximation at moderate couplings, but it is also a lot of work, and for purposes of this paper we have just adopted the expedient of selecting the lowest value of E_B in a range of τ for which $D_1/D_0 < .5$.

Our results, over a range of three orders of magnitude in e^2 are shown in Fig. 7. Here we have plotted the ratio $\Delta E_{RR}/\Delta E_{BS}$ as a function of e^2 , and also, for comparison, $\Delta E_{NR}/\Delta E_{BS}$. The deviation of $\Delta E_{NR}/\Delta E_{BS}$ away from 1 is a rough indication of the magnitude of relativistic effects. Relativistic effects start to be noticeable for $e^2 = 10^{-2}$, and it is gratifying that over a range of two orders of magnitude in the coupling $10^{-2} < e^2 < 1$, our variational bound on the binding energy holds steady at about 80% of the value computed from the Bethe-Salpeter equation. At couplings $e^2 \gg 1$ all

weak-coupling methods break down, and neither our method nor the ladder approximation of the Bethe-Salpeter equation can be trusted.

5. Possible Applications

The method outlined above gives a definite prescription for calculating the energy of multi-gluon trial states in QCD, of the form

$$Q_{-T} = \int DA(x,t < 0) Q_{-T}(A) \delta[F(A)] \det \Delta(A) e^{-\int_0^\infty dt d^3x_k T_{RR}}$$

$$Q_{-T} = \int d^3x_1 d^3x_2 \dots d^3x_n \int_{\mu_1 \mu_2 \dots \mu_n}^{a_1 a_2 \dots a_n} (x_1 x_2 \dots x_n)$$

$$\cdot A_{\mu_1}^1(x_1, -T) A_{\mu_2}^2(x_2, -T) \dots A_{\mu_n}^n(x_n, -T), \quad (5)$$

providing that the average gluon separation R and time-split T are small enough so that $\langle H \rangle$ can be evaluated perturbatively. That specifying a state requires both a definite Q_{-T} and a definite gauge-fixing condition $F[A]=0$. States with the same Q_{-T} in different gauges are, in general, non-equivalent.

Consider an operator Q_{-T} with glueball quantum numbers, which creates a 2-gluon wavepacket of radius R . If R is not too large the energy of such a state can be calculated from diagrams such as those shown in Fig. 8. The energy $E_B(R)$ should go like

$$E_B(R) = \frac{C_1}{R} + \frac{C_2 g_{eff}^2(R)}{R}, \quad (5)$$

where the first term comes from the zeroth order kinetic energy ($C_1 \approx 1$ depends on the detailed shape of the wavepacket), while the second term includes both 2-gluon interaction and self-energy contributions.

Now it is certainly possible to choose R so large that the perturbative calculation is meaningless. But there is at least a hope that a local minimum

$$\left. \frac{\partial E_B(R)}{\partial R} \right|_{R_B} = 0 \quad (5.3)$$

occurs at some $R = R_B$ such that $g_{\text{eff}}^2(R_B)$ is still within the domain of perturbation theory. In that case, we get a variational estimate $E_B(R_B)$ for the low-lying glueball mass. The procedure also has a reasonable (in fact, better) chance of working for massive quarkonium states.

According to the picture of string formation advocated in ref. (4), as a quark and an antiquark separate, they will tend to reduce the effective color charge separation by pulling out a chain of gluons between them, as shown in Fig. 9. In this case the relevant diagrams through $O(g^2)$ are again shown in Fig. 8, only this time, for the planar contributions, the interactions are between nearest neighbor gluons in the chain. If R is the average separation of nearest-neighbor gluons, L is the $q\bar{q}$ separation, and $\epsilon(R)$ is the kinetic energy + self-energy + nearest-neighbor interaction energy, then

$$E = \epsilon(R) \cdot \frac{L}{R} \quad (5.4)$$

is the total energy in the chain, and R is to be found by minimizing

$$\left. \frac{\partial}{\partial R} \left[\frac{\epsilon(R)}{R} \right] \right|_{R_S} = 0 \quad (5.5)$$

Once again, it is at least possible that a minimum occurs inside

the perturbative domain, in which case

$$\mu = \epsilon(R_S)/R_S \quad (5.6)$$

is an estimate of the string tension.

So the variational method leads to a concrete program for estimating QCD hadronic properties. This approach has the virtue that, being based on perturbation theory, it survives in the large- N limit (for a critique of other non-perturbative mechanisms at large N , see ref. (4)). That the program may also fail is obvious. The minima (4.3), (4.4) may not exist in the perturbative regime, or may not exist at all, or the energy at the minimum may be tachyonic (a possibility advocated by Hansson, Johnson and Peterson (8)).

The only way to know for sure is to carry out the actual (and fairly tedious) calculation.

Acknowledgments

This work was begun at Niels Bohr Institute. J.G. would like to thank Holger Nielsen for a number of helpful discussions, and M.B.H. thanks the theory group for its gracious hospitality.

References

- [1] H.A. Bethe and E.E. Salpeter, "Quantum Mechanics of One- and Two-Electron Atoms", (Springer-Verlag, Berlin 1957); G.P. Lepage, Phys. Rev. A16 (1977)863; G.T. Bodwin and D.R. Yennie, Phys. Rep. 43 (1978)267.
- [2] G. Wick, Phys. Rev. 96 (1954)1124; R. Cutkosky, Phys. Rev. 96 (1954)1135.
- [3] R. Jaffe and K. Johnson, Phys. Lett. 60B (1976)201; P. Hasenfratz, R. Horgan, J. Kuti, and J. Richard, Phys. Lett. 95B (1980) 299.
- [4] J. Greensite, "Monte-Carlo Meets the Fishnet: String Formation in a Gas of Feynman Diagrams", Nucl. Phys. B (in press).
- [5] C. Thorn, Phys. Rev. D19 (1979)639.
- [6] K. Ishikawa, M. Teper and G. Schierholz, Phys. Lett. 110B 1982)399.
- [7] K. Wilson, remarks at Cosener's House Lattice Gauge Theory meeting (Abingdon, UK March 1981).
- [8] T. Hansson, K. Johnson, and C. Peterson, Phys. Rev. D26 (1982)2069.

Footnotes

- F1) Note that this action is unbounded from below; i.e., the Wick-Cutkosky model, like any ϕ^3 model, is a bottomless-action theory, and the Euclidean functional integral is not well-defined. To rigorously define the Euclidean theory, one may either treat ϕ_1, ϕ_2, A as $N \times N$ matrix-valued fields and take the $N \rightarrow \infty$ limit, or else apply a stochastic stabilization prescription which we have discussed elsewhere (Nucl. Phys. (1984)167).
- F2) This replacement may be obtained by end-point differentiation of eq. (2.1) using

$$\pi(x) = -i \frac{\delta}{\delta \phi(x_0)}.$$
 Without our time-split parameter T , a small time-splitting $\epsilon = 0^+$ must be introduced directly into H , e.g.,

$$\pi \rightarrow -\frac{1}{2}[\dot{\phi}^*(x, \epsilon) + \dot{\phi}(x, \epsilon)]^* (x, -\epsilon).$$
 However, $T > 0$ serves the purpose of ϵ , so that in our method ϵ may be neglected. The curious minus sign in the replacement is due to the fact that this is a Euclidean representation of H .
- F3) Alternately, E_B may be computed from the logarithmic derivative, with respect to the time-splitting, of a Euclidean point function. In this paper, we opt for the more physically transparent (but non-covariant) diagrammatic formalism presented below.
- F4) In principle, self-energy loops thru $0(g^2)$ should also be included in the calculation. These loops are neglected in our ladder approximation of the Bethe-Salpeter equation. Since

are going to compare our results with solutions of the Bethe-Salpeter equation, it is reasonable to make the comparison using the same approximation, i.e., neglecting the self-energy loops.

F5) In gauge theories the situation is different. There one can go to the Coulomb gauge, which involves an instantaneous, long-range interaction term, leading to a Coulombic $1/r$ potential even as the time-split $T \rightarrow 0$. Time-splitting is still necessary, however, to obtain the proper magnetic contributions to the energy.

Figure Captions

- Fig. 1. Feynman rules for the variational calculation in the Wick-Cutkosky model. Cross (x) vertices come from the Hamiltonian defined at time $t=0$.
- Fig. 2. Diagrammatic representation of terms in the numerator and denominator of eq. (3.7) (a symmetric trial state $f(k_1, k_2) = f(k_2, k_1)$ is assumed).
- Fig. 3. Contributions to diagram N_2 , which lead to an attractive potential. Fig. 3a shows an exchange process in the parameter range $|Y_0| < T$. For sufficiently large T this gives a $1/r$ Coulomb-type potential. Fig. 3b shows interaction via pair production in the vacuum, a process in the range $|Y_0| > T$, which does not give a $1/r$ potential.
- Fig. 4. $|\Delta E_{RR}(\tau)|$ vs. τ at $e^2 = .001$. Note that since $\Delta E_{RR} < 0$, $|\Delta E_{RR}(\tau)|$ is a lower limit on $|\text{binding energy}|$.
- Fig. 5. $|\Delta E_{RR}(\tau)|$ vs. τ at $e^2 = .022$.
- Fig. 6. $|\Delta E_{RR}(\tau)|$ vs. τ at $e^2 = .5$.
- Fig. 7. The ratios $\Delta E_{RR}/\Delta E_{BS}$ (and $\Delta E_{NR}/\Delta E_{BS}$) vs. the dimensionless coupling e^2 .
- Fig. 8. Relevant graphs for a variational glueball or gluon-chain calculation.
- Fig. 9. Gluon-chain picture of the QCD string. The ovals represent constituent gluons in the chain, which are pictured as a product of quark and antiquark charges.

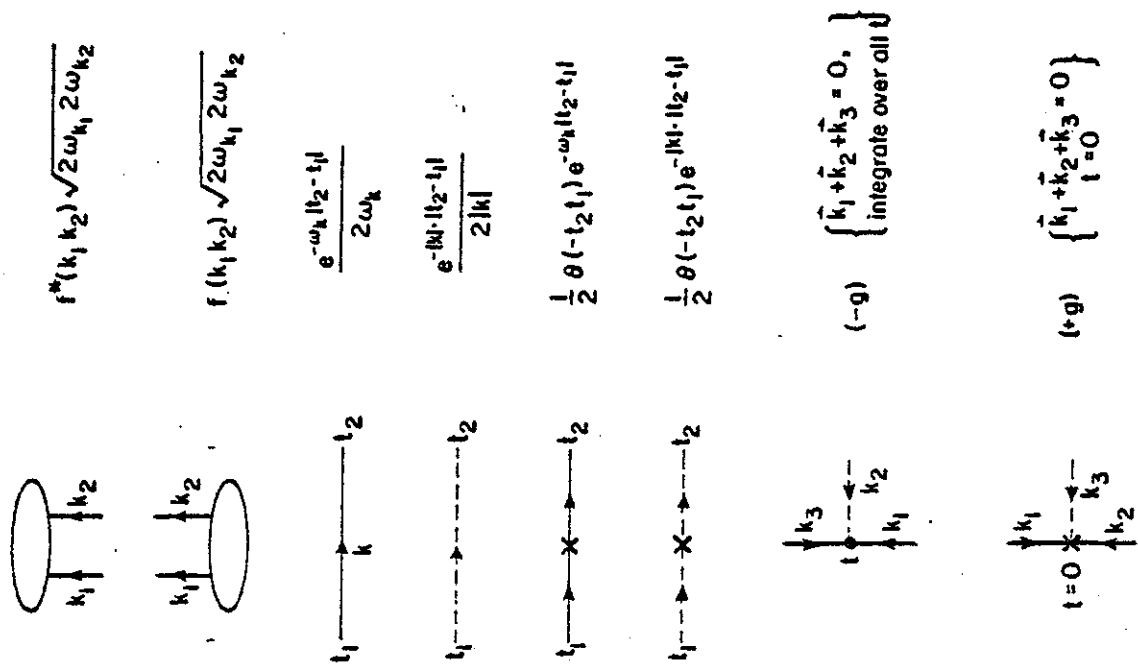

Figure 1

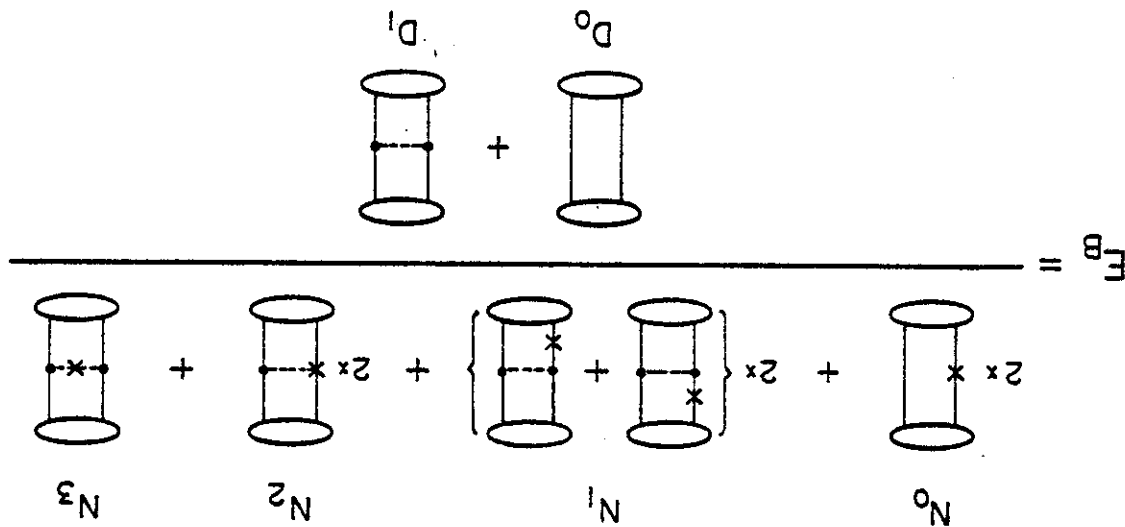

Figure 2

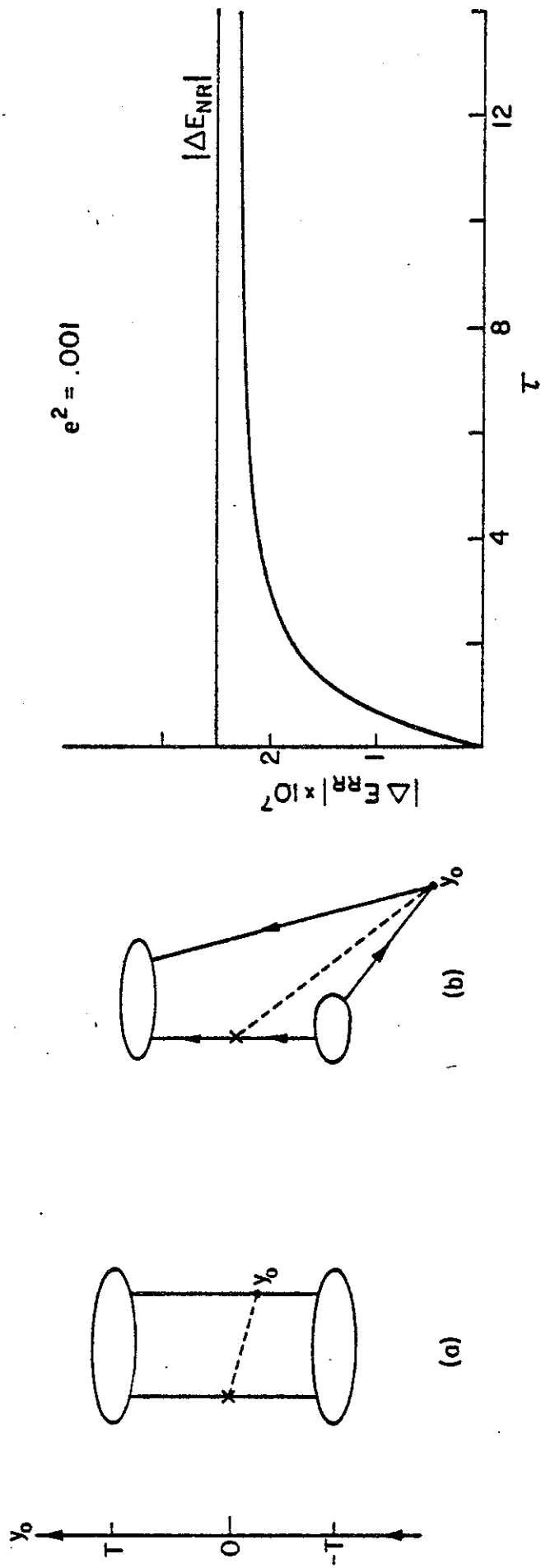

Figure 4

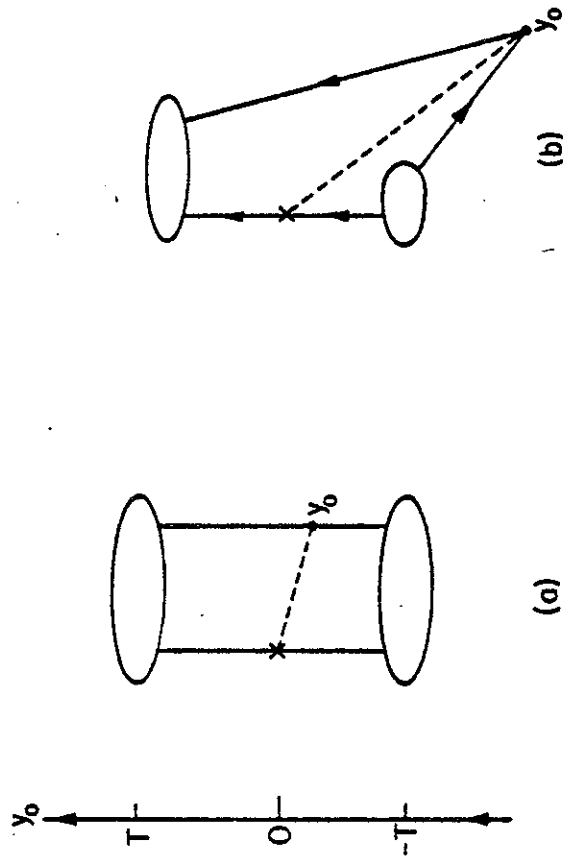

Figure 3

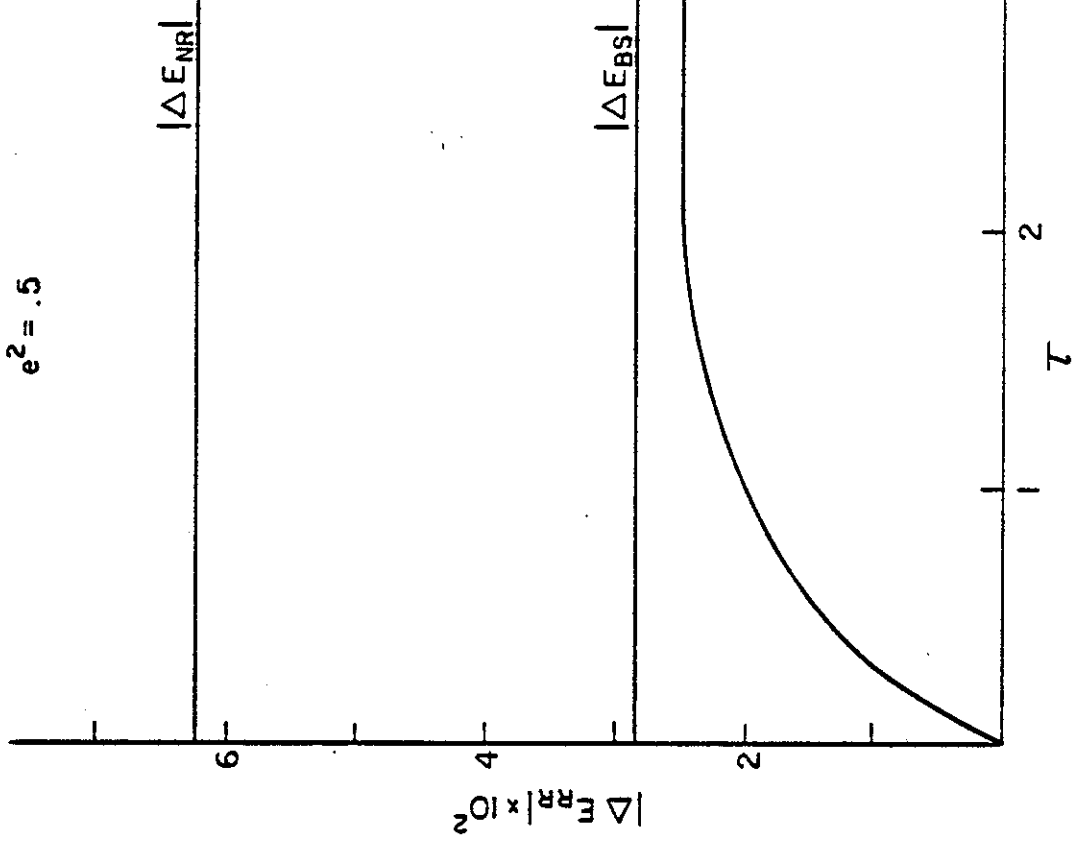

Figure 6

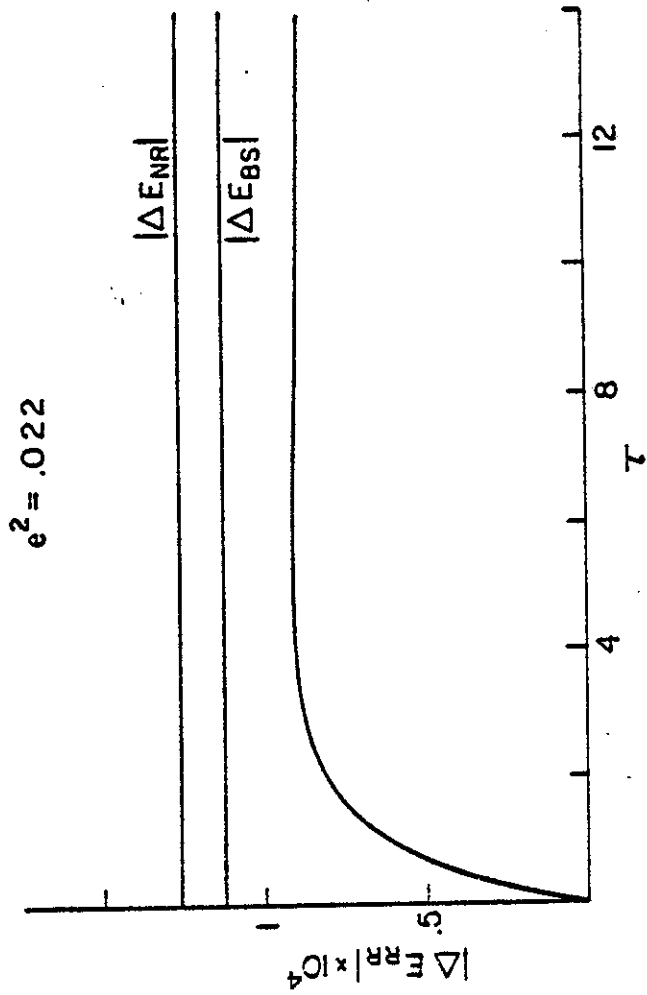

Figure 5

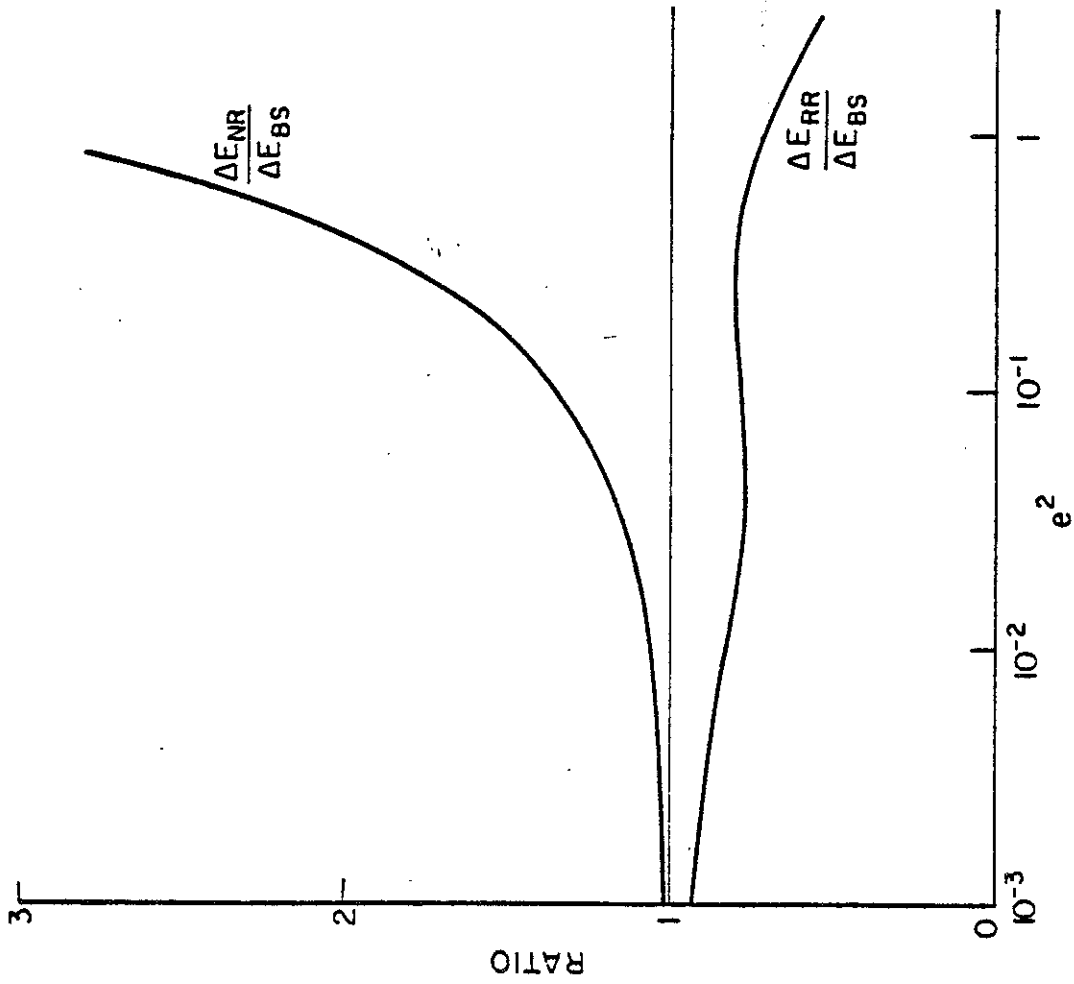

Figure 7

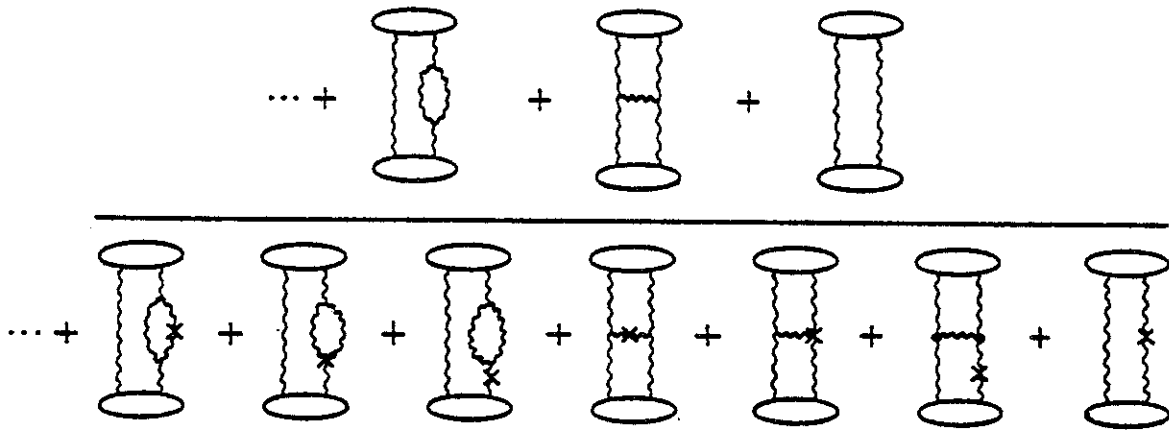

Figure 8

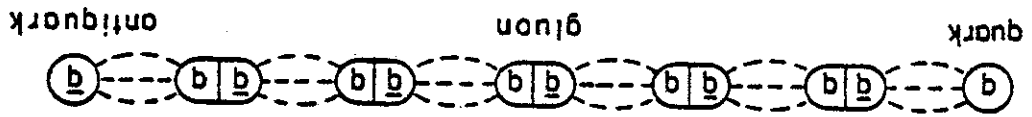

Figure 9

